

ORECK[®] XL[®]

SIMPLY AMAZING[®]

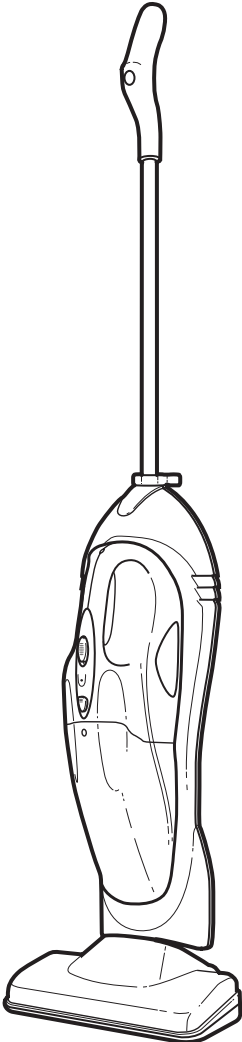

MODEL AV-701B

**REGISTER YOUR PRODUCT
ON THE WEB:
WWW.ORECK.COM**

USER'S GUIDE

cord-free
electric broom
2 MOTOR SYSTEM



USA: 1-800-989-3535

CANADA: 1-888-676-7325



WWW.ORECK.COM



VISIT ONE OF OUR
OVER 400 LOCATIONS

•IMPORTANT•
SAVE THIS BOOKLET!

Includes:
Important Safety Instructions
Warranty
Operating Instructions

IMPORTANT SAFETY INSTRUCTIONS

When using an electrical appliance, basic precautions should always be followed, including the following:

READ ALL INSTRUCTIONS BEFORE USING THIS VACUUM CLEANER



WARNING
**To reduce the risk of fire,
electric shock, or injury:**

- Do not use outdoors or on wet surfaces.
- Do not expose to rain, store indoors.
- Do not allow to be used as a toy. Close attention is necessary when used by children.
- Use only as described in this manual. Use only manufacturer's recommended attachments.
- Do not use extension cords or outlets with inadequate current carrying capacity.
- Do not handle charger or vacuum cleaner with wet hands.
- Do not incinerate or mutilate batteries as they will explode at high temperatures.
- Do not pick up anything that is burning or smoking such as cigarettes, matches, or hot material.
- Do not use without a filter in place.
- Do not allow the battery to run down completely before charging. In doing so, serious problems may occur in the battery life cycle.
- Do not pick up flammable or combustible liquids such as gasoline, or use in areas where they are present.
- Store the adapter indoors in a cool dry area not exposed to the weather to avoid electrical shock and/or cleaner damage.
- Only use the adapter provided by the manufacturer to recharge the appliance.

Additional Safeguards

- Always disconnect cord from electrical outlet before servicing the cleaner.
- Only charge the unit indoors.

Lubrication

- Lubrication is not necessary since the motor and brush roll are permanently lubricated.

SAVE THESE INSTRUCTIONS
Household Use Only

If the adapter or the interconnection cord is damaged, it must be scrapped.

IMPORTANT BATTERY HANDLING INSTRUCTIONS

When using an electrical appliance containing a lead-acid battery, basic precautions should always be followed, including the following:

READ ALL INSTRUCTIONS BEFORE CHARGING THE BATTERY



WARNING

To reduce the risk of fire,
electric shock, or injury:

Battery Charging

- Charge batteries for 10 -12 hours before initial use.
- Never modify the electrical system. Alterations could cause a fire resulting in serious injury and could also ruin the electrical system.
- Use of the wrong type battery or charger could cause a fire or explosion resulting in serious injury.
- The battery must be handled by adults only. The battery is heavy and contains sulfuric acid (electrolyte). Dropping the battery could result in serious injury.
- Never allow children to charge the battery. Battery charging must be done by adults only. A child could be injured by the electricity involved in charging the battery.
- Never lift or carry the battery by the wires or connector. This can damage the battery and possibly cause a fire resulting in serious injury. Lift and carry the battery by the case only.
- Read the safety instructions on the battery.
- Examine the battery, charger and their connectors for excessive wear or damage each time you charge the battery. If damage or excessive wear is detected, do not use the charger or the battery until you have replaced the worn or damaged part.

Care

- If a battery leak develops, avoid contact with the leaking acid and place the damaged battery in a plastic bag. Please refer to the information on this page for proper disposal.
- If acid comes in contact with skin or eye, flush with cool water for at least 15 minutes and call a physician.
- If acid is internally ingested, give water, milk of magnesia or egg whites immediately. Never give emetics or induce vomiting. Call a physician.
- Do not allow the battery to run down completely before charging.
- Charge the battery at least once per month, even if the vacuum has not been used.
- Leaving the battery in a discharged condition will ruin it.
- Do not store the battery in temperatures above 75°F or below -10° F.

Disposal

- The battery is a sealed lead-acid battery. It must be recycled or disposed of in an environmentally sound manner. Do not dispose of a lead-acid battery in your regular household trash. The incineration, landfilling or mixing of sealed lead-acid batteries with household trash is prohibited by law in most areas.
- Return exhausted batteries to a federal or state approved lead-acid battery recycler, such as a local seller of automotive batteries. Contact your local waste management officials for other information regarding the environmentally sound collection, recycling and disposal of lead-acid batteries. If you live in the State of Florida or Minnesota, it is prohibited by law for anyone to throw lead-acid batteries in the municipal waste stream.

Warranty

ORECK MANUFACTURING COMPANY: (ORECK gives you the following limited warranty for this product only if it was originally purchased for use, not resale, from ORECK or an ORECK Authorized Retail Dealer.)

ORECK will repair or replace, free of charge, to the original purchaser, any part which is found to be defective in material or workmanship within one (1) year of the date of purchase. This limited warranty applies to normal domestic use. Any commercial use of this product will void this limited warranty.

This limited warranty does not cover the replacement of expendable or consumable parts such as belts, brushes, bulbs, batteries and other parts subject to normal wear.

This limited warranty does not apply to any part subjected to accident, abuse, commercial use, alteration, misuse, damage caused by fire or act of God, the use of voltages other than indicated on the serial number plate of this product or service of this product by other than ORECK or an ORECK Factory Authorized Service Center.

ORECK does not authorize any person or representative to assume or grant any other warranty obligation with the sale of this product.

ORECK's limited warranty is valid only if you retain proof of purchase from ORECK or an ORECK Authorized Retail Dealer for this product. If you purchase this product from any other source, your purchase is "AS IS," which means ORECK grants you no warranty, and that you, not ORECK, assume the entire risk of the quality and performance of this product, including the entire cost of any necessary servicing or repairs of any defects.

ORECK's liability for damages to you for any costs whatsoever arising out of this statement of limited warranty shall be limited to the amount paid for this product at the time of original purchase, and ORECK shall not be liable for any direct, indirect, consequential or incidental damages arising out of the use or inability to use this product.

Some states do not allow the exclusion or limitation of incidental or consequential damages, so the above limitation or exclusion may not apply to you.

ALL EXPRESS AND IMPLIED WARRANTIES FOR THIS PRODUCT, INCLUDING IMPLIED WARRANTIES OF MERCHANTABILITY AND FITNESS FOR A PARTICULAR PURPOSE, ARE LIMITED IN DURATION TO THE WARRANTY PERIOD, AND NO WARRANTIES, WHETHER EXPRESS OR IMPLIED, WILL APPLY AFTER THIS PERIOD.

Some states do not allow limitations on the duration of implied warranties, so the above limitation may not apply to you.

This warranty gives you specific legal rights, and you may also have other rights which vary from state to state.

Assembly

MODEL AV-701B

1. ON/OFF handle switch
2. Adjustable handle control lever
3. Release button for hand held unit
4. Charging socket A
5. Hand held unit on/off switch
6. Battery (built-in the hand held unit)
7. Charging lamp
8. Release button for dirt cup
9. Dust filter (included in the hand held unit)
10. Reset button
11. Brush lamp
12. Power brush
13. Crevice tool (built-in)
14. Upholstery brush
15. Adapter (power supply/charger)
16. Charging socket B

Accessories

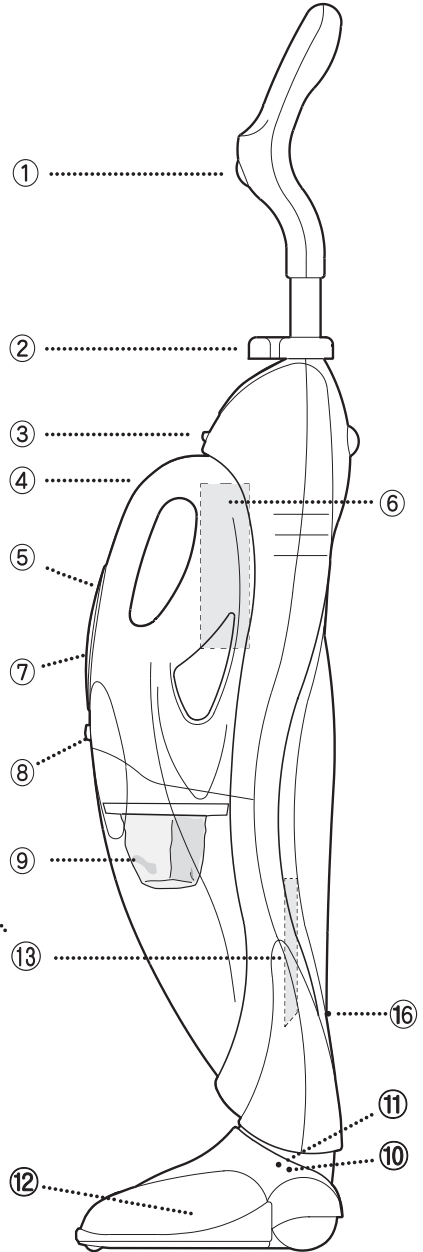
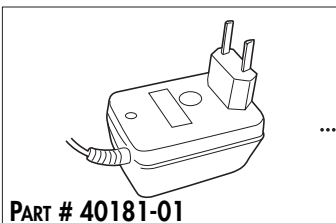
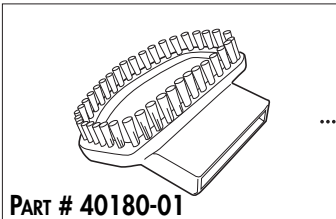
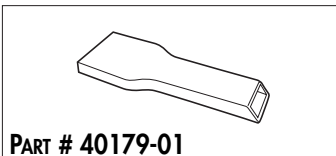

Operating Instructions

Charging the Unit

1. Before charging, make sure both switches are in the “off” position. Then insert the adapter into an electrical outlet and the plug into charging socket A or B. Charge batteries for 10 - 12 hours before initial use. Normal charging time is 8 - 10 hours. After that time, the cleaner will run for approximately 15 - 20 minutes.

Caution: Do not allow the battery to run down completely before charging. In doing so, serious problems may occur in the battery life cycle.

2. A red lamp indicates the unit is charging. A green lamp indicates the unit is fully charged. If you have a charging problem, refer to the chart in the “Troubleshooting” section.
3. It is normal for the adapter to feel warm while the battery is charging.
4. The cleaner can be on a constant charge so it is always ready for use (it is over-charge protected). However, if the cleaner will not be used for several weeks at a time, unplugging it is recommended.

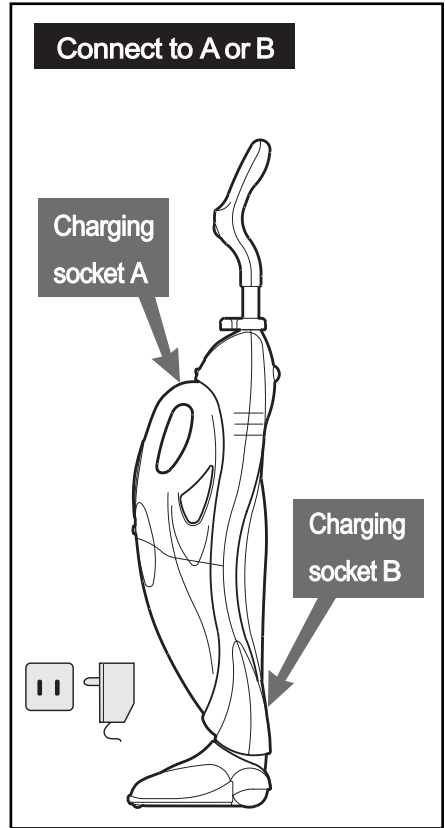

ON/OFF handle switch

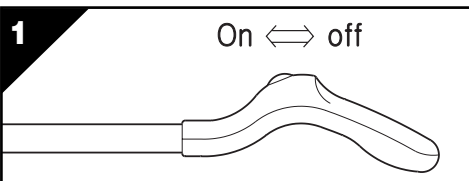

Fig. 1
One-touch sliding “On/Off” switch for convenient use.

Release Button

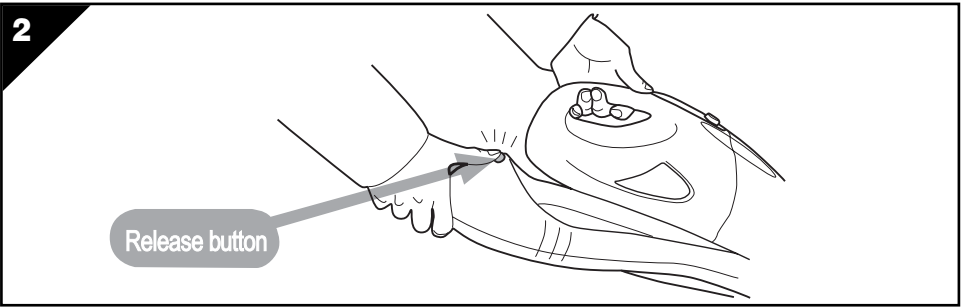

Fig. 2 To remove the hand held unit, push the release button. When finished cleaning, align the hand held unit against the wall bracket of the stick broom and snap it into place.

Hand Held Unit ON/OFF Switch & Charging Indication Lamp

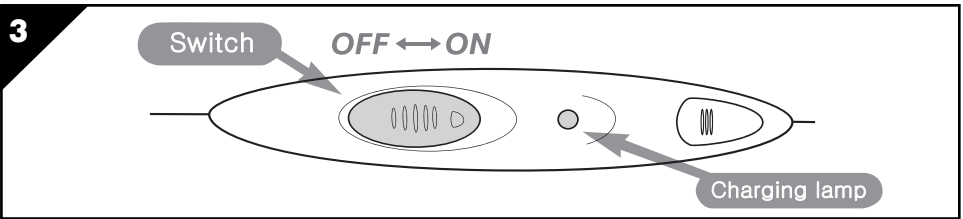

Fig. 3 A red lamp indicates the unit is charging. A green lamp indicates the unit is fully charged.

Adjustable Handle Control Lever

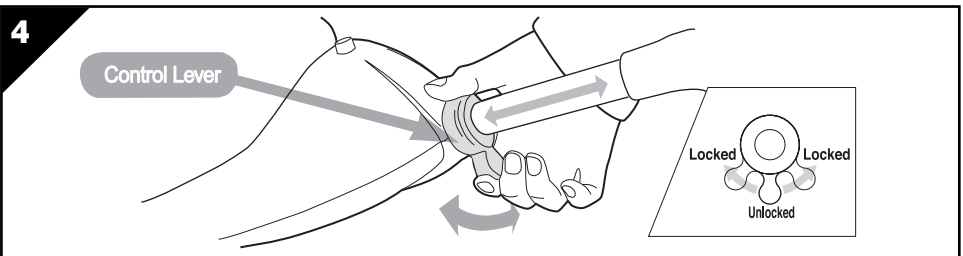

Fig. 4 The handle can be set to desired working position. Loosen the handle by turning the control lever to the center position, then pull the handle to the desired length and secure it by turning it to the locked position.

Cleaning the Dust Filter

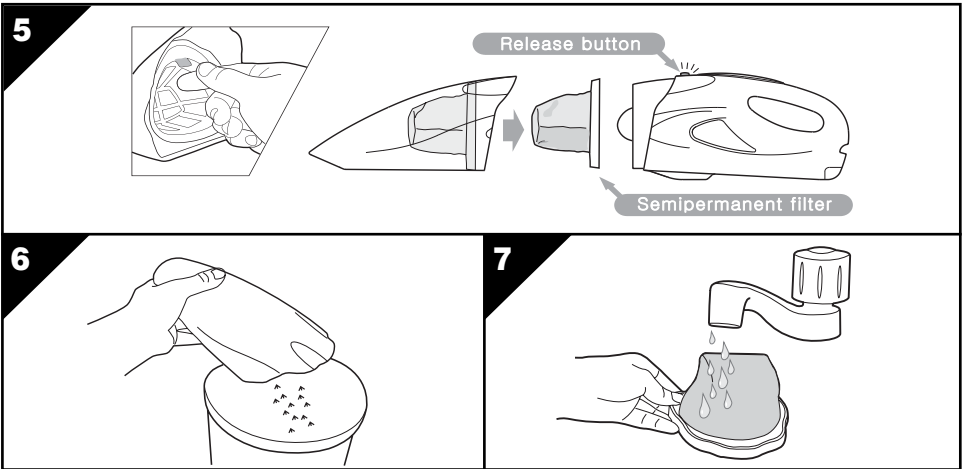
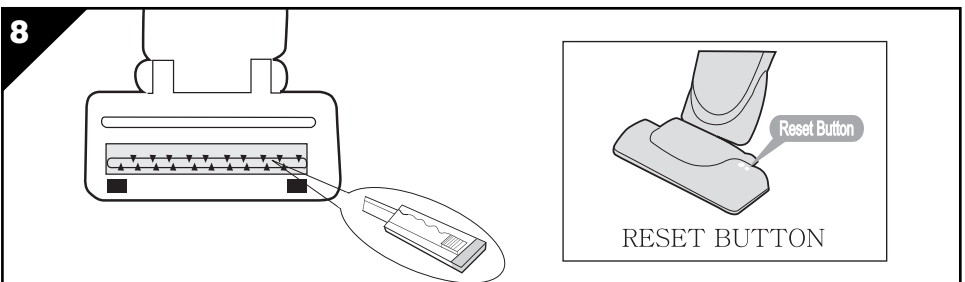

Fig. 5 Press the release button and remove the dirt cup from cleaner.

Fig. 6 Empty the dirt cup.

Fig. 7 It is also recommended to empty and clean the filter after each use. To remove debris from the filter, tap it on a hard surface or brush it with a soft brush. The filter can be washed in warm soapy water using a soft brush if necessary. Dry it completely before replacing it into the dirt cup.

Power Brush



Important: Disconnect cleaner from electrical outlet.

Fig. 8 To maintain cleaning effectiveness, regularly remove hair, lint, strings, threads, etc. from the brush roll with a knife or scissors. If a blockage resulting from hair, lint, strings, etc. is caught in the brush roll, the cleaner will stop automatically for safety purposes. After removing the blockage, push the “reset button” on the brush assembly. A green light will appear in the brush lamp next to the reset button and the cleaner should run normally.

Removing and Replacing the Battery

(See Important Battery Handling Instructions on page 2)

Note: Do not remove the battery to charge it. The battery should only be removed if you plan to replace it or you are disposing of the cleaner.

Examine the battery, charger and their connectors for excessive wear or damage each time you change the battery. If damage or excessive wear is detected, do not use the charger or the battery until you have replaced the worn or damaged party.

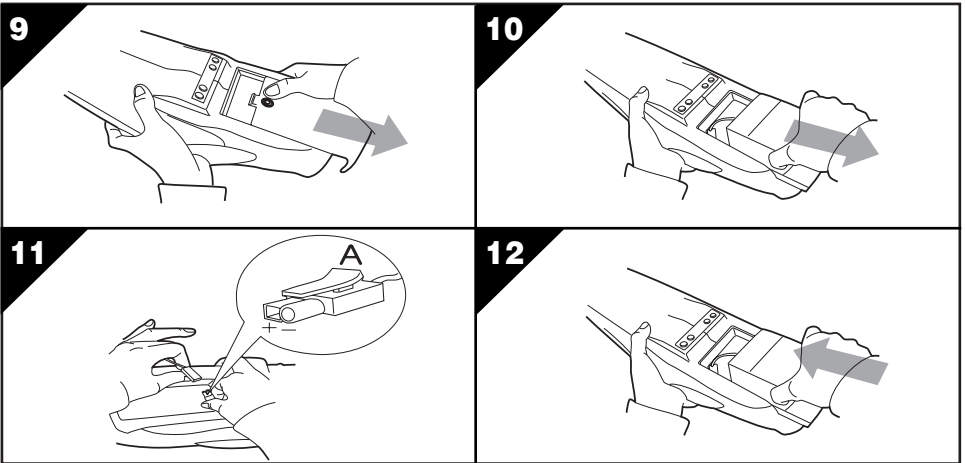

Fig. 9 Slide the battery cover off the bottom of the hand held unit.

Fig. 10 Remove the battery from the motor housing.

Fig. 11 Press tab on connector “A” to release battery from motor housing. Plug new battery into connector “A”. (Be careful to connect plus and minus pole correctly.)

Fig. 12 When inserting the battery into the motor housing, the wires must go in first and they must be placed in front of the battery. Replace battery cover.

Battery Disposal

Your cleaner is equipped with a replaceable sealed lead-acid battery (Type No. LC-R064R2P). When the battery no longer charges, it must be removed from the cleaner and disposed of in an environmentally safe manner.

Do not dispose of a lead-acid battery in your regular household trash.

The incineration or mixing of sealed lead-acid batteries with household trash is prohibited by law in most areas. Return exhausted batteries to a federal or state approved lead-acid battery battery recycler. Contact your local waste management officials for other information regarding the environmentally sound collection, recycling and disposal of lead-acid batteries. If you live in the State of Florida or Minnesota, it is prohibited by law for anyone to throw away lead-acid batteries in the municipal waste stream.

Troubleshooting Guide

PROBLEM	AREAS TO CHECK
What happens if the red charging indicator is not lit while charging?	<ul style="list-style-type: none">➤ Make sure the adapter plug and socket are plugged in properly.➤ Both the hand held unit and the stick broom need to be turned off while charging.
The green light is on and the unit is fully charged, but the unit is inoperative.	<ul style="list-style-type: none">➤ Remove adapter from charging socket.➤ Charge battery again.➤ New battery may be required, contact an Authorized Service Center.
Suction power is not sufficient.	<ul style="list-style-type: none">➤ Empty dirt cup and clean dust filter.➤ Charge battery again.➤ New battery may be required, contact an Authorized Service Center.
Running time is not sufficient.	<ul style="list-style-type: none">➤ Charge battery again.➤ New battery may be required, contact an Authorized Service Center.
Machine does not stop when switched off.	<ul style="list-style-type: none">➤ Separate hand held unit from the stick broom.➤ Both switches on the hand held unit and the stick broom must be in the off position.
Brush does not work while operating.	<ul style="list-style-type: none">➤ Clean the power brush.➤ Push the reset button and turn it on again.➤ Contact an Authorized Service Center.
Hand held unit works, but the stick broom does not.	<ul style="list-style-type: none">➤ Take the hand held unit off and locate the four (4) silver prongs on the bottom of the unit. If the prongs are not clean, wipe them with a dry cloth.➤ Contact an Authorized Service Center.